

Smappee EV Wall HOME

Installation manual



Document Accuracy

The specifications and other information in this document were verified to be accurate and complete at the time of its publication. Due to ongoing product improvement, this information is subject to change at any time without prior notice. For the latest information, see our online documentation: <https://www.smappee.com/downloads>

Table of contents

1. Introduction	4
2. Safety instructions.....	5
3. Models	7
4. Components.....	8
5. Technical specifications.....	10
6. Preparing the installation	13
7. Installation and activation	16
8. Using the EV Wall Home	32
9. Declaration of conformity	36

1. Introduction

Thank you for purchasing this Smappee EV Wall Home charging station for electric vehicles, the smartest charging station for charging at home.

This installation and user manual tells you how to install and use the Smappee EV Wall Home. We advise you to read the contents of this manual carefully, to ensure a safe and proper installation and enable you to use all the advanced features of this product to their full extent.

Support

Only qualified electricians or equivalent may install the Smappee EV Wall Home. If you have any questions, please contact your service partner.

Please have the following information ready to hand to speed up the process: Article number and serial number which you can find on the identification label of the charging station.



Should your local distributor be unable to help you, or you have a suggestion for us, you can contact Smappee at: **support@smappee.com**.

Smappee n.v.
Evolis 104
8530 Harelbeke
Belgium

2. Safety instructions

Safety warning

Fully read and follow the safety instructions below before you install, service or use your Smappee EV Wall Home. The installer must ensure that the charging station is installed in accordance with the relevant national and local regulations.

Carrying out activities on this charging station without the relevant knowledge and qualifications can lead to serious accidents and death. Only carry out tasks for which you are qualified and have been fully instructed.

Incorrect installation, repairs or modifications can result in danger to the user and may void the warranty and liability.

Safety precautions

	CAUTION: Risk of electric shock.
	CAUTION: Refer to the accompanying documentation whenever you see this symbol.

Please observe the following safety precautions to avoid potential electric shock, fire, or personal injury:

- The charging station is intended exclusively for charging electric vehicles and, when installed correctly, may be used by untrained individuals.
- Switch off electrical power supply to your charging station before installation or maintenance work.
- Do not use the charging station if damaged / defective.
- Do not immerse the charging station in water or any other liquids.
- Do not expose the charging station to heat, flame or extreme cold.
- Do not attempt to open, repair, or service any parts. Contact Smappee or your service partner for further information.
- Only use the charging station under the specified operating conditions.
- Do not allow children to operate a charging station.
- When a charging station is in use, adult supervision of any children present is required.
- While charging the charging cable must be completely unwound and connected to the electric car without overlapping loops. This to avoid the risk of overheating the charging cable.

Maintenance

- Observe the maintenance schedule.
- Clean the outside only with a dry, clean cloth.
- Do not use abrasive agents or solvents.
- May not be carried out during rain or if air humidity exceeds 95%.

Keeping order

- After charging store the charging cable properly so it does not present a tripping hazard.
- Make sure the charging cable cannot become damaged (kinked, compressed or driven over).
- Do not place any objects on the charging station.

Transport and storage

- Disconnect electrical power supply before removing the charging station for storage or relocation.
- Only transport and store the charging station in its original packaging. No liability for damage incurred will be accepted if the charging station is transported in non-standard packaging.
- Store the charging station in a dry environment within the temperature range specified in the technical specifications.

3. Models

Article no.	EAN	Description
EVW-132-BR-E-W	5425036931916	EV Wall Home White 1-Phase 7.4 kW Socket
EVW-132-BR-E-W-100A	5425036932524	EV Wall Home White 1-Phase 7.4 kW Socket (100A version)
EVW-132-BSR-E-W	5425036932722	EV Wall Home White 1-Phase 7.4 kW Socket with shutter
EVW-132-C8R-E-W	5425036931992	EV Wall Home White 1-Phase 7.4 kW Type 2 cable 8m with cable holder
EVW-132-C8R-E-W-100A	5425036932548	EV Wall Home White 1-Phase 7.4 kW Type 2 cable 8m with cable holder (100A version)
EVW-332-BR-E-W	5425036932036	EV Wall Home White 3-Phase 22 kW Socket
EVW-332-BR-E-W-100A	5425036932555	EV Wall Home White 3-Phase 22 kW Socket (100A version)
EVW-332-BSR-E-W	5425036932739	EV Wall Home White 3-Phase 22 kW Socket with shutter
EVW-332-C8R-E-W	5425036932111	EV Wall Home White 3-Phase 22 kW Type 2 cable 8m with cable holder
EVW-332-C8R-E-W-100A	5425036932579	EV Wall Home White 3-Phase 22 kW Type 2 cable 8m with cable holder (100A version)

4. Components

Components included

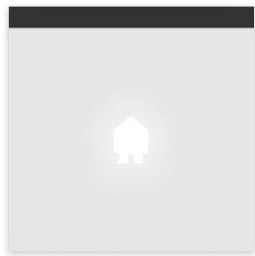

EV Wall



EV Wall splitter



DIN mounting plate



Connect



Wall mounting plate



QR code sticker



Quick Install Guide



CT Hub



CT 50A



Bus termination plug



RJ10 cable 40 cm



RJ10 cable 150 cm



Smart Charge Card

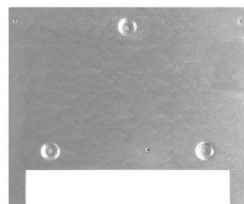

EV Wall mounting plate



Screw & plug



Small screw

In case of three phase connection set-up:



CT 50A



Solid Core 3-phase CT

Type 2 EV charging cable

In case of a fixed cable version the cable is supplied in a separate box.

1. 1 x 8 m open-ended to type 2 EV charging cable
2. 1 x cable tie for strain relief
3. 1 x EV cable holder + 2 x screws + 2 x plugs

Identification label

The identification label of your charging station is located on the left inside of the EV Wall Home.

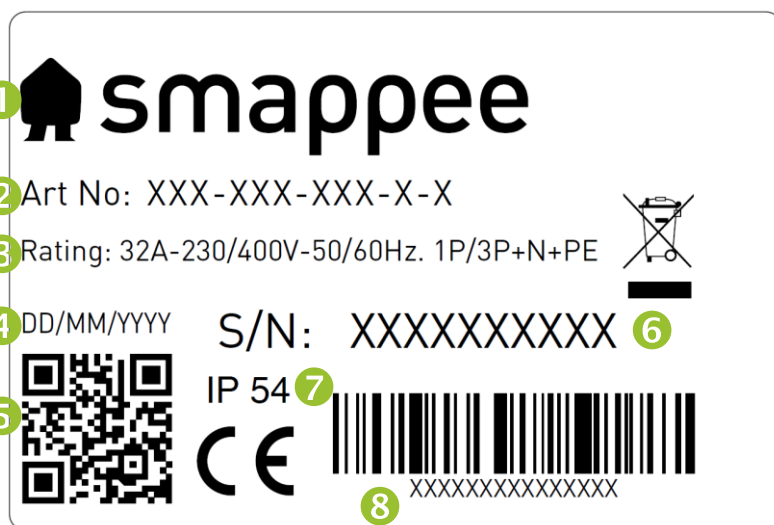

1. Manufacturer
2. Article number
3. Rating
4. Manufacturing date
5. QR code containing article number and serial number
6. Serial number
7. Degree of protection
8. EAN code

5. Technical specifications

Feature	Description	
	Socket	Type 2 cable
Technical features		
Charging capacity	Single or triple phase, 7.4 to 22 kW	
Output power	1-phase or 3-phase, 230 V – 400 V, 16 A or 32 A	
Charge mode	Mode 3 (IEC 61851)	
Connection case	1 x Case B (Socket type 2)	1 x Case C (Fixed cable with type 2 connector)
Metering	kWh meter compliant with IEC 62053-21	
Integrated Residual Current Protection	Rated operating residual current detection: 6 mA DC / 30 mA RCD Type A	
Supported power systems	TN-C, TN-C-S, TT, IT* * Caution: not all vehicles support the IT system. In that case, or with 3-phase charging a voltage transformer is required.	
Grounding	TN system: PE wire TT system: Independently installed ground electrode < 100 Ohm spreading resistance IT system: connected to a shared reference (common earth) with other metal parts	
Rated voltage (U_n)	230 V – 400 V	
Rated insulation voltage (U_i) of a circuit	500 V	
Rated impulse withstand voltage (U_{imp})	4 kV	
Rated frequency (f_n)	50 Hz / 60 Hz	
Rated current (I_{na})	32 A	
Rated current (I_{nc}) of a circuit	32 A	
EMC classification	Class B	
Connection method	AC, permanently connected	
Short circuit protection	1-phase: 1 x 32 A max 1P, type B or C 3-phase: 1 x 32 A max 3P, type B or C	
Interfaces & Connectivity		
Information status	RGB LED	
Session activation	Plug and charge, Scan QR code, Swipe RFID card, Smart EV schedules	
Connectivity	Ethernet 100BASE-T	

Communication protocol	OCPP 1.6 JSON, ready for update to OCPP 2.0	
Certifications and Standards		
Product certification	CE	
Standards	IEC 61851-1 (2017)	
Environment		
Enclosure material	Steel (housing), aluminium (front plate)	
Enclosure standard colours	RAL9016 (star white) + RAL7021 (black grey)	
Protection degree	IP 54	
Mechanical impact protection	IK10	
Pollution degree	3	
Electrical safety class	I	
Stand-by use	LED brightness 0%: 2 W LED brightness 100%: 5 W	
Environmental conditions	Indoor and outdoor use	
Operating temperature	-25 °C to 40 °C	
Storage temperature	-25 °C to 60 °C	
Relative humidity	0 % - 95 %, non-condensing	
Maximum installation altitude	0 – 2.000 m	
Access	Locations with restricted and non-restricted access	
Physical properties		
Dimensions	300 x 300 x 110 mm	
Weight (excluding packaging)	6.2 kg	9.8 kg
Charging cable length	N/A	1 x 8 m
Supply line connection	Terminal block, flexible conductors up to 6 mm ² or solid conductors up to 10 mm ²	
Stationary / moveable	Fixed installation	
External design	Enclosed assembly	
Mounting method	Wall	



The operating temperature assumes the ambient temperature of a product delivered in the default enclosure colours RAL9016 (star white) + RAL7021 (black grey). Direct exposure to sunlight may have an adverse effect on the temperature range.

If the product is exposed to lower or higher ambient temperatures, continuous operation cannot be guaranteed. If temperatures exceed the maximum values, the charging station will automatically decrease the charging current to decrease the internal temperature of the charging station.
This stabilises the internal temperature and makes it less likely that a transaction will be unexpectedly paused.

If the product is directly exposed to sunlight, the automated temperature management may automatically start below the maximum ambient temperature. Therefore, wherever possible, avoid exposing the charging station to direct sunlight.

Where products are exposed to the elements of nature, the enclosure can be subject to gradual aging of the material, which can result in product discolouration over time. Therefore, wherever possible, place the product in a sheltered place to optimise the life of the materials.

6. Preparing the installation

The first step is to prepare the physical installation of the EV Wall Home as described in this chapter.

Installation prerequisites

- Calculate the existing electrical load to find the maximum operating current for the charging station installation. The Smappee EV Wall Home is equipped with 1 connector (socket or fixed cable) which needs to be powered.
- Obtain all necessary permits from the relevant local authority.
- Refer to local wiring regulations to select the conductor sizes and use only copper conductors.
- Make sure that the installation area of the charging station is adequate for usability and ventilation purposes.
- Use the correct tools and provide sufficient material resources and protection measures.

Power supply

- The appropriate wire gauge of the supply cable depends on the power rating and distance between the meter cabinet and the charging station. The voltage drop must not exceed 5%. It is advisable to have a maximum voltage drop of 3 %.
- The maximum wire gauge that can be fitted is 6 mm² in case of flexible conductors or 10 mm² when solid conductors are used.
- The power supply trajectory from the circuit breaker panel up to the EV Wall Home charging station must be protected against short-circuiting and over-current with B or C circuit breakers (or otherwise in compliance with local standards and regulations)
- A charging station connector must always be installed on a dedicated power circuit.
- When the power supply and the charging station are part of a TN-S system, the station must be grounded via the main distributor.
- Route the power supply cables to the position where the charging station will be installed together with an Ethernet cable for the internet connection (if applicable).
- Make sure that there is at least 30 cm cable available at the location of the EV Wall Home to be able to connect it easily internally.
- Local regulations may be applicable and can vary depending upon the region or country.



The power supply enters the station at the bottom of the housing through the middle cable gland.

The Cat 5/6 communication cable also enters the charging station via the floor plate. Ensure that you attach the RJ-45 connector only **after** inserting the cable into the EV Wall Home housing.

The maximum power rating for each connector is specified in the table below.

Power per connector	Connection	Input current	Output current
7.4 kW	1-phase	1 x 32 A	1 x 32 A
22 kW	3-phase	3 x 32 A	3 x 32 A

Route communication cable

The EV Wall Home requires a communication cable between the EV Wall Home and the distribution panel where the CT measurements and Connect gateway are placed. To do this, two twisted pairs of a Cat 5 or Cat 6 networking cable are used. The Cat 5/6 cable should be connected between the PCB of the EV Wall Home's front plate and the splitter in the distribution panel. An RJ-45 connector (not supplied) should be attached to both ends of the cable. Only attach the RJ-45 connector **after** inserting the cable into the housing. The RJ-45 connector will not fit through the EV Wall Home's cable gland!

Prepare the mounting

All Smappee EV Wall Home types are designed to be mounted on a wall.

When positioning the EV Wall Home, take into account that the power supply cables and communication cable are entering the housing at the bottom through cable glands. The central M32 cable gland is for the power supply, the M20 cable gland for the communication cable.

Tools (not included)

- Screwdrivers
- 3mm Hex screwdriver
- 7mm socket wrench with extension bar
- Multimeter and earth ground meter
- Wire stripper and cutter.
- Needle-nose pliers.
- Ferrules crimper, for stranded power supply cables
- Drill and rock drill diameter 10 mm.
- Hammer
- RJ45 crimping tool

Supplies (included)

- 3 x wall plugs and screws anchors (\varnothing 6 mm x 50 mm)
- 3 x M4 x 6 mm HEX screws

Supplies (not included)

- CAT 5/6 cable and two RJ45 connectors for wired communication cable.
- Power supply cables
- Ferrules (6 mm²), for stranded power supply cables
- 32 A circuit breaker

7. Installation and activation

This procedure describes the required steps for the physical installation of the EV Wall Home.

	CAUTION: Make sure it is not possible to connect the electric current during installation. Put up caution tape and warning signs to mark the work areas. Make sure no unauthorised people can enter the work areas.
	CAUTION: The electric system must be entirely disconnected from every power source prior to performing installation or maintenance work. Make sure it is not possible to connect the electric current during installation. Put up caution tape and warning signs to mark the work areas. Make sure no unauthorised people can enter the work areas.
	CAUTION: The charging station contains electric components that may still contain electrical charge after being disconnected. Wait at least 10 seconds after disconnection before commencing work.
	CAUTION: Adaptors or conversion adaptors and cord extension sets are not allowed to be used.

Place the mounting plate in position

- Use the mounting plate to mark the position of the screws on the wall where the EV Wall Home is to be positioned. Make sure the mounting plate is positioned with the 2 insert holes on the bottom, as depicted below.

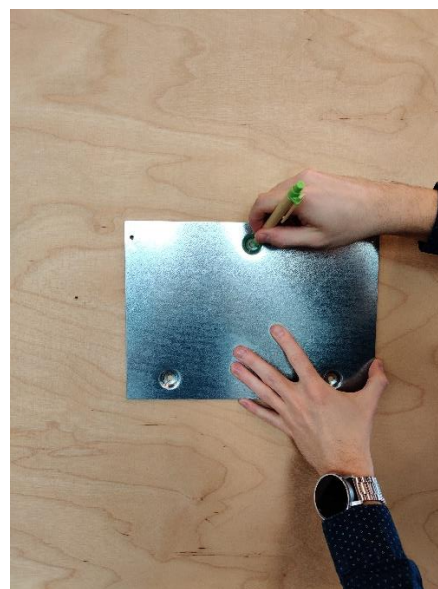
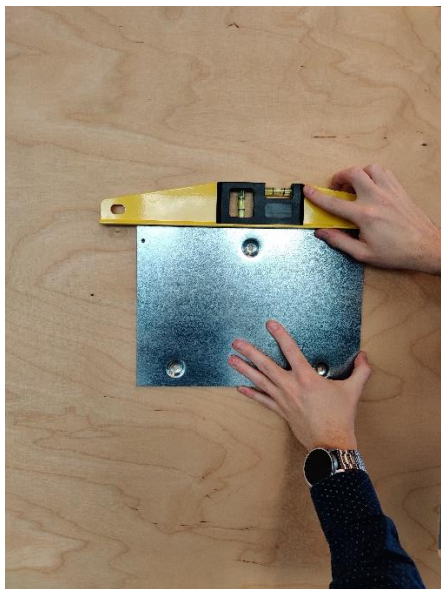

- b. Drill 3 holes of 10 mm diameter through the slots to a depth of 50 mm. Insert the supplied wall plugs into the holes.



- c. Attach the mounting plate to the wall with the supplied screws.

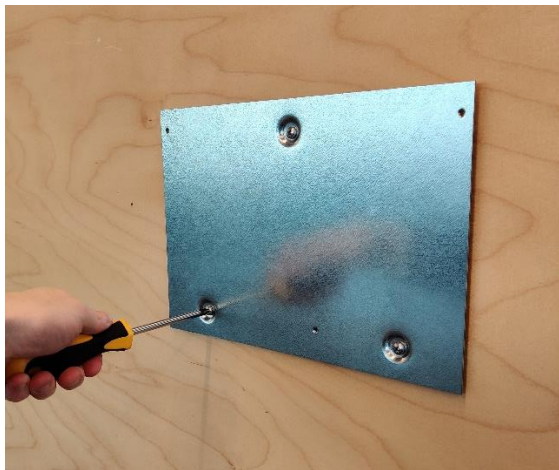

Place the EV Wall Home in position

- a. Remove the front plate of the EV Wall Home and disconnect the communication cables. Safely put aside the front plate to avoid damaging the PCB-board attached to it.

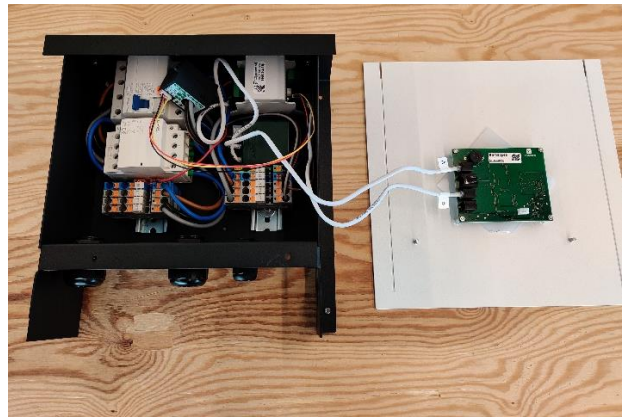
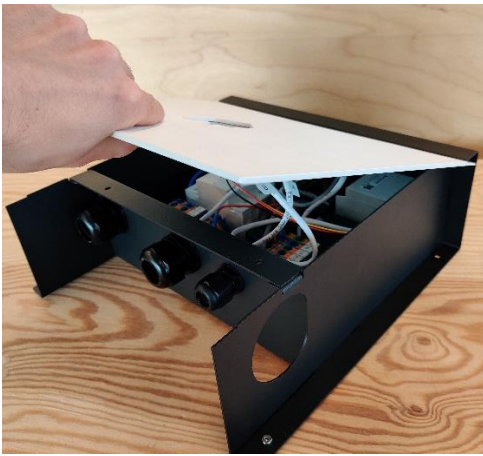

- b. Attach the EV Wall Home housing to the mounting plate using the three supplied M4 x 6 mm HEX screws.

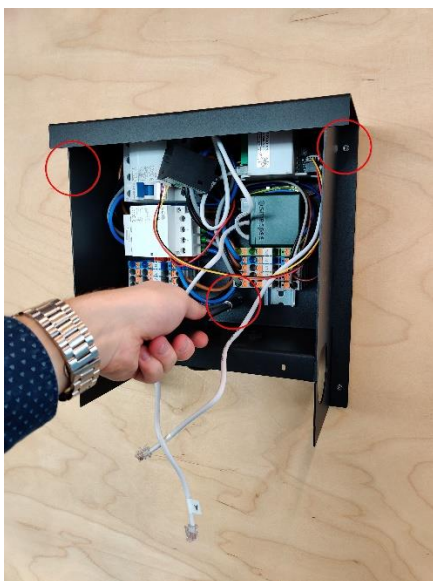

Power supply connection

- a. Slide the power cable through the middle cable gland.

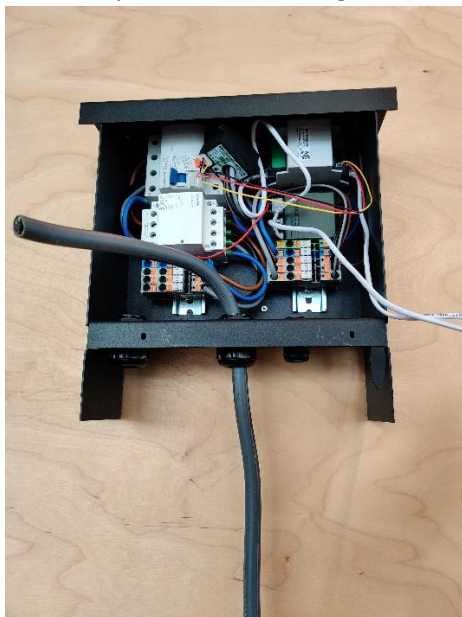

- b. Cut the power supply cables to adequate length and add the ferrules to each conductor if stranded cables are used.
- c. Measure the resistance of the grounding circuit and make sure that it is within acceptable limits. If necessary, install a grounding point closer to the charging station.
- d. Connect each supply cable to the terminal block. If you have a single-phase power supply, only the L1 and N will need to be connected.

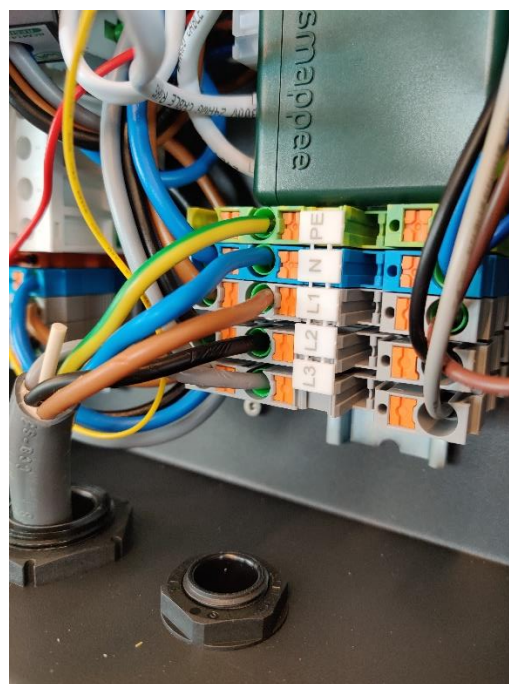
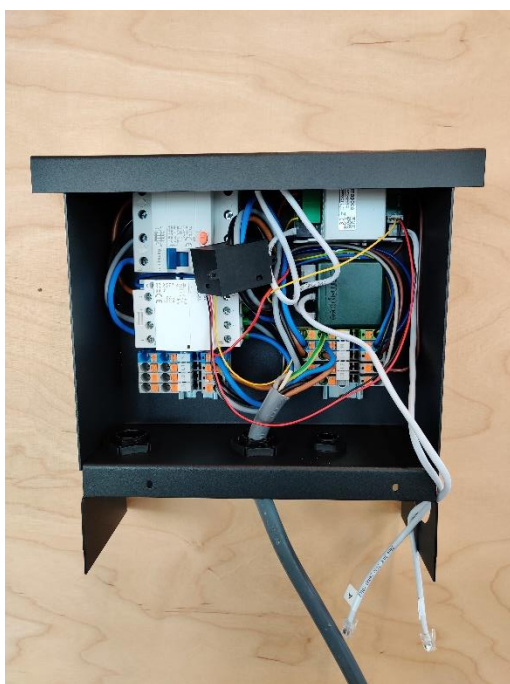

EV charging cable mounting (only fixed cable version)



This section is only relevant if the EV Wall Home comes with a fixed cable. If you have a socket version, please continue to the next section.

- a. Mount the fixed charging cable through the left M32 cable gland and mount the power supply wires to the terminal block. Do not forget to connect the small white CP data cable. The CP cable is white, except for products purchased before January 2022 which have an orange CP cable.

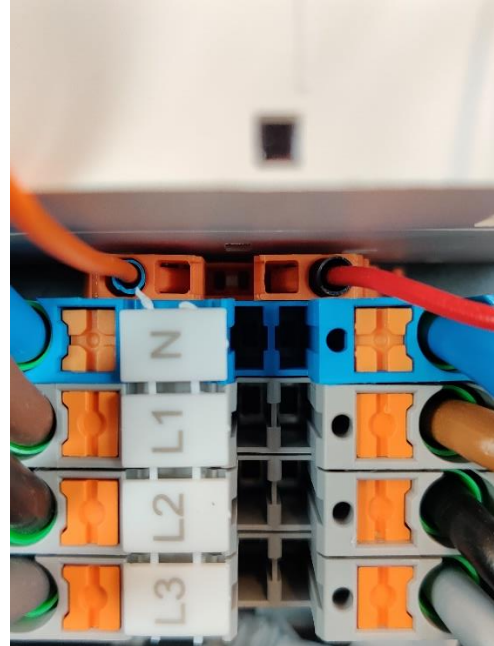
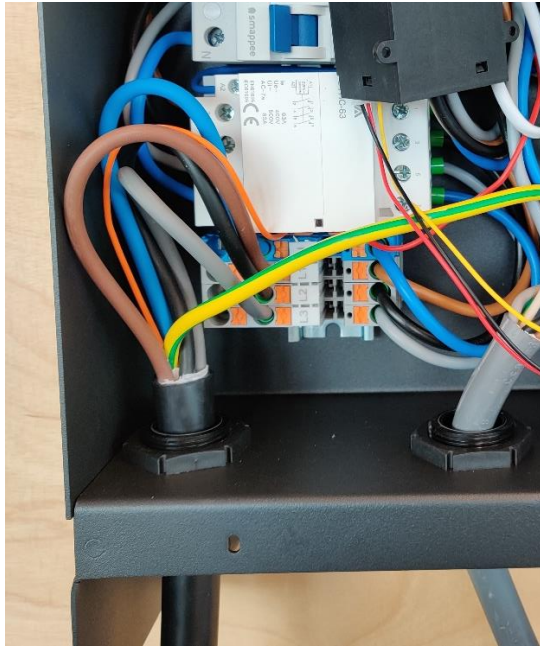

- b. Mount the cable tie for strain relief on the charging cable after it enters the M32 cable gland.



- c. Mount the separate cable holder on the wall nearby the EV Wall Home. As the cable socket is situated on the righthand side of the EV Wall Home, we advise to mount the cable holder on the

same side.



The length of the fixed cable can be shortened if required. Cut the cable to its required length and add ferrules (not supplied).

Installation in distribution panel

This chapter describes the installation of the Infinity components in the distribution panel. These components enable overload protection & solar optimization supplied with the EV Wall Home.

The EV Wall Home package comes with the required Smappee Infinity components to be installed in the distribution panel to measure the main feeder (total grid consumption) and single-phase solar production. If three-phase solar is present, the EV Wall Home Solar Add-on can be purchased.

Depending on the EV Wall Home type (1-phase or 3-phase), the included Smappee Infinity components varies:

- EV Wall Home 1-Phase:
 - 1 x Connect
 - 1 x CT Hub
 - 3 x CT 50A (1x grid + 1x solar +1x EV measurement)
 - 1 x EV Wall Home splitter
- EV Wall Home 3-Phase:
 - 1 x Connect
 - 1 x CT Hub
 - 4 x CT 50A (3x grid + 1x solar measurement)
 - 1 x Solid Core 3-Phase CT (EV measurement)
 - 1 x EV Wall Home splitter



If additional CT measurements need to be added, standard Infinity hardware (CT Hubs and CTs) can be purchased and installed in addition to the EV Wall Home components. Always keep the Smappee Infinity installation guidelines in mind.

For installation of these components, please refer to the diagrams on the next page.

The main installation steps include:

- a. Install the 32 A circuit breaker (not supplied) according to local regulations. In case of a three-phase EV Wall Home: install the supplied solid-core CT together with the circuit breaker.
- b. Install the CTs as indicated on the diagrams on the next page. Connect these to the supplied CT Hub.
- c. Install the Smappee Connect and EV Wall Home splitter. The Smappee Connect should be placed inside or near the distribution panel. It requires a stable internet connection via Wi-Fi or Ethernet.
- d. Connect the A- and B-bus cables as indicated on the diagram. Connect the Cat 5/6 communication cable to the RJ45 port of the splitter.



Ensure that the CT Hub(s) are connected to the A-port of the Smappee EV Wall Home splitter and the Smappee Connect to the B-port of the Splitter. Also check that the Cat 5/6 communication cable is connected to the splitter and NOT to the Smappee Connect.

Connection diagram EV Wall Home – 1-phase (1P+N)

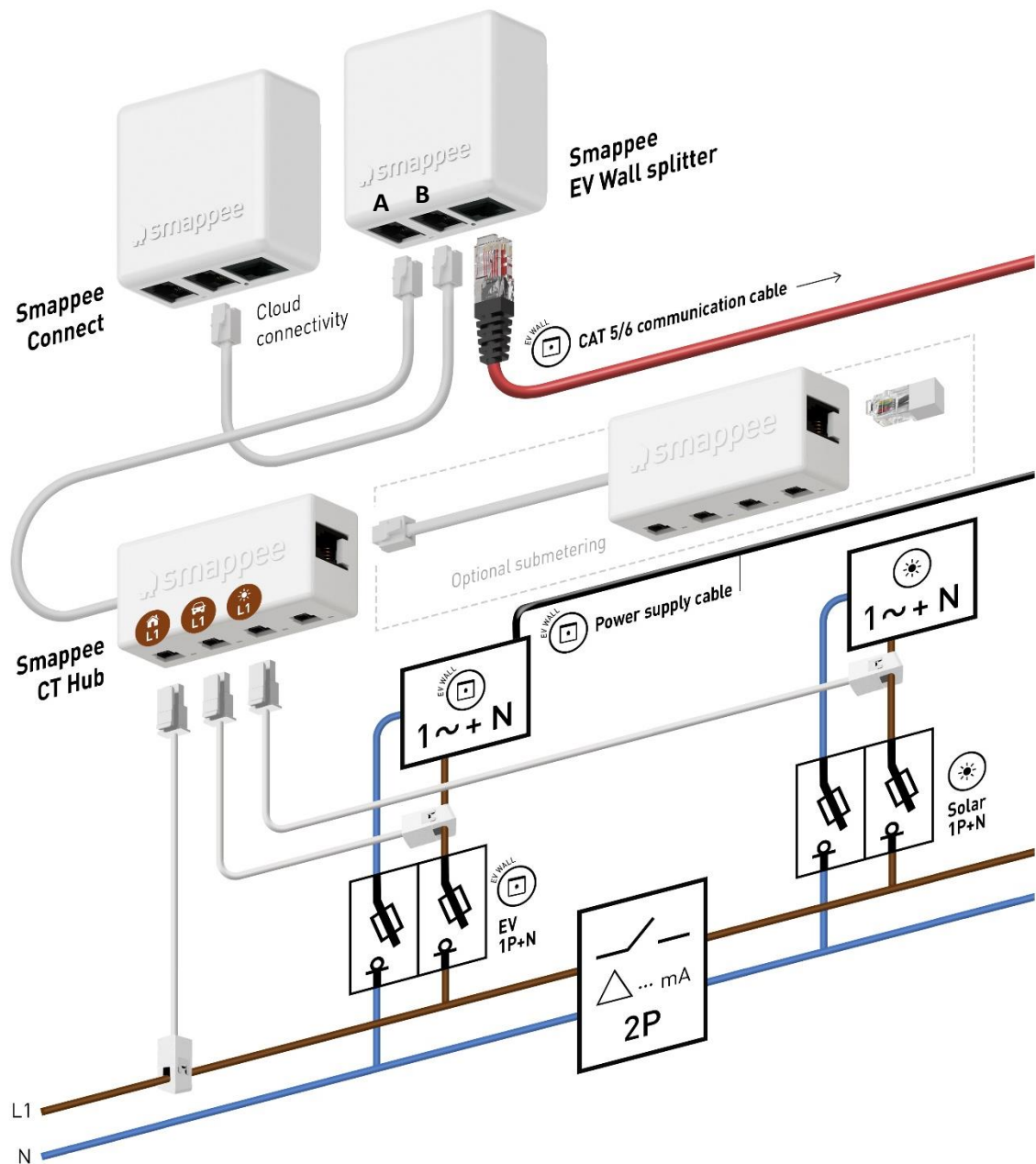

If you have purchased a three-phase version of the EV Wall Home, it is possible to connect it to a single-phase installation. In this case, you must still respect the stickers and connect it as shown in the three-phase diagram on the next page, but without L2 and L3.

IMPORTANT notes for 3P (3 x 230 V) – Delta topology



This section is only relevant if you have a delta grid topology, which is only found in some parts of Belgium, Norway and France. If this is not applicable, you can skip this section.

When an EV Wall Home is installed in a residential installation with a 3P (3 x 230 V) Delta grid connection, some additional requirements need to be taken into account. You can verify whether you have this topology by checking the grid connection to see if the following are true:

- There is no neutral wire.
- The voltage between two phases is approximately 230 V.
- The voltage between a phase and earth is approximately 130 V.

Some EVs are not compatible with this type of grid connection due to a built-in security in the EV. Contact your EV manufacturer for more information.

The security feature that some EVs have is a voltage check between the phase that is connected as neutral and the ground. If this is not 0 volts, the car won't charge. The presence of this security feature may vary for each manufacturer and for each model.

As there is no neutral wire available in this topology, the L3 will be used as neutral. In this case, some EVs will be able to charge dual phase (using both L1 and L2) and some will only charge single phase. In practice, this may limit the maximum charging power. This again varies for each EV manufacturer and each model.

If your EV is not compatible with this grid topology, or if you would like to achieve higher charging power than what is possible on a delta grid topology, you can install a transformer. This transformer will convert the 3 x 230 V delta topology to a standard 3 x 400 V star topology.

Without transformer

If you are connecting the charging station directly to the 3 x 230 V delta grid, without transformer, please refer to the diagrams below.

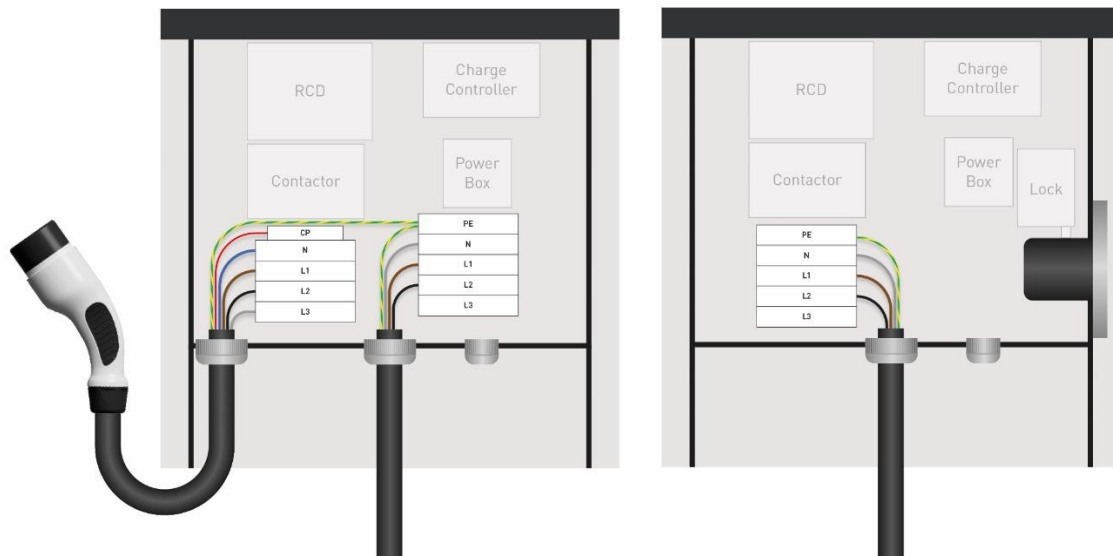

We highly recommend that you test compatibility with the customer's EV during installation. If you have connected the EV Wall Home as shown above but the EV will not charge, you can try to disconnect the L2 cable going to the charging cable or to the socket. Do not disconnect the L2 of the power supply cable!

If you install an EV Wall Home on a 3 x 230 V delta grid connection without transformer, the Infinity components in the distribution cabinet should be connected as shown below:

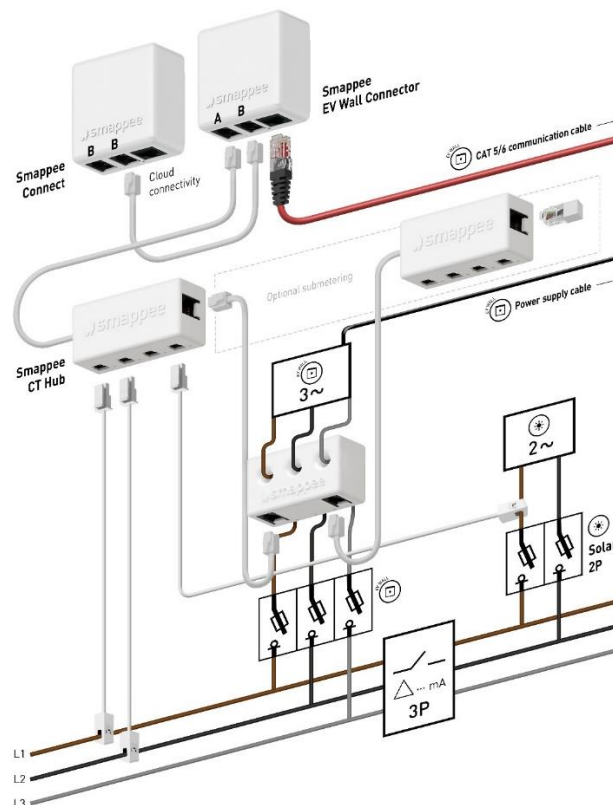

Note that when you measure single-phase loads or solar panels, you must connect and configure the CT(s) as shown below:

Single phase consumer/producer powered by	Connect the clamp around	Phase measured by this CT
L1 and L3	L1	L1
L2 and L3	L2	L2
L1 and L2	L1	L3

With transformer

If a transformer is used to convert the 3 x 230 V delta connection to a standard 3 x 400 V star with neutral, then the charging station's power supply can be connected as usual. Please refer to the pictures on previous pages for this. The connection in the distribution cabinet is still a little different, as shown in the diagram below.



When a transformer is used in combination with a 3 x 230 V delta topology, the purchase of an additional Smappee Power box is required. This will be placed inside the distribution panel. In this case, the Power Box inside the EV Wall Home becomes redundant and both RJ10 cables should be disconnected.

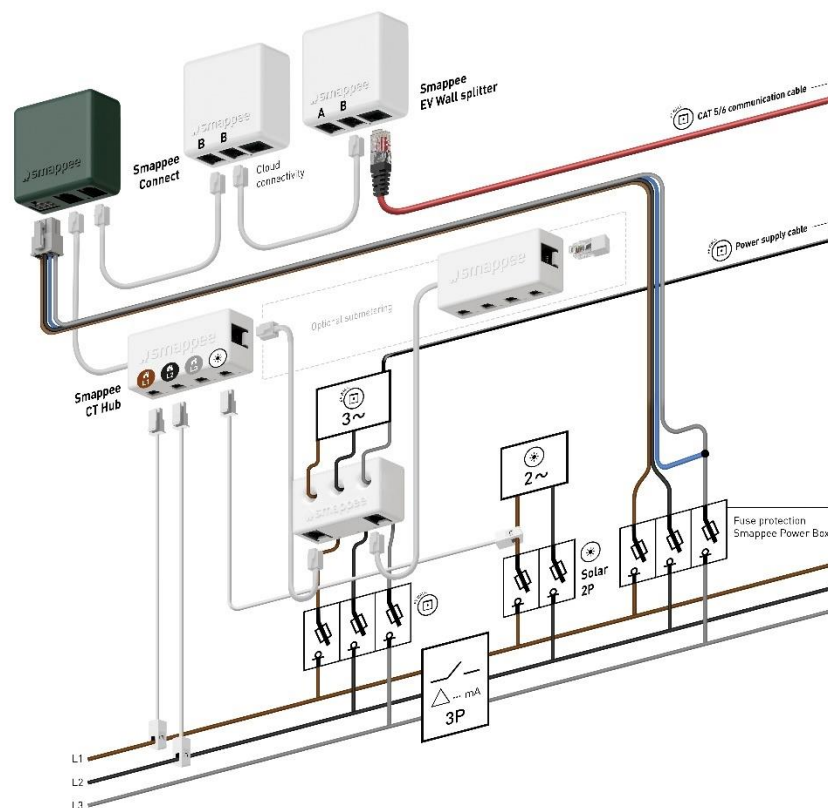

Note that when you measure single-phase loads or solar panels, you must connect and configure the CT(s) as shown below:

Single phase consumer/producer powered by	Connect the clamp around	Phase measured by this CT
L1 and L3	L1	L1
L2 and L3	L2	L2
L1 and L2	L1	L3

Closure



Make sure that the RCD switch is set to the 'On' position before closing the EV Wall Home

- a. Mount the front plate into position by connecting the RJ10 cables and Cat 5/6 cable to the PCB attached to the front plate. Pay attention to stickers and connect each cable to the corresponding input.

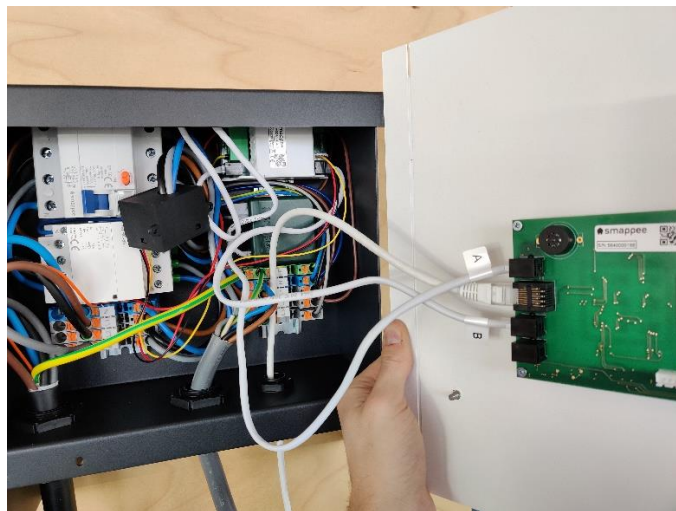
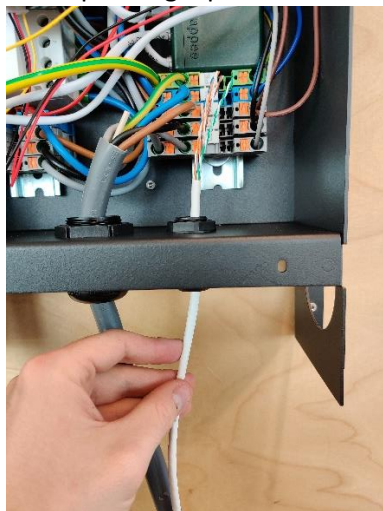

Be careful to connect the RJ10 cables to their corresponding input. Do not connect a cable marked 'A' to an input marked 'B' and vice-versa.

In case of a 3 x 230 V delta topology **with** transformer (see special notes on previous page), only the B cable should be connected.

b. Mount and tighten the supplied M4 nuts



Do not overtighten the M4 bolts on the front plate.

Switching on the EV Wall Home



All communication cables must be attached to the front panel before powering the EV Wall Home.

- a. Check all connections are secure and power-up the EV Wall Home.
- b. Check the status LEDs:
 - Charging controller: green flashing light (1 x per 3 seconds)
 - RCM: continuous green light
 - Power Box: green flashing light (1 x per 3 seconds)

Activation

This procedure is done with the Smappee mobile app. You can download this from the Apple App Store for iOS or the Google Play store for Android phones.



The Smappee App will guide you through the various steps to fill in all the required information.

- Log in to the Smappee App with the given Smappee username or create a new user account.
- Install a Smappee car charging station.
- Follow the steps shown in the mobile app.



The settings of your charging station can be adjusted in the Smappee Mobile app or Dashboard.

- Smappee Mobile App: Name, Maximum current per connector, Charging speed per connector and LED brightness
- Dashboard: Name, Maximum current per connector, Phase assignment per connector, Charging speed per connector and LED brightness

8. Using the EV Wall Home

There are three ways of charging using a Smappee EV Wall Home:

1. Plug and charge: Simply connect your cable and start charging.
2. Swipe and charge: Connect the cable, swipe your card and start charging.
3. Scan and charge: Connect the cable, scan the QR code in the Smappee app and start charging.

Below you can find the different charging sequences.

	Each EV Wall Home that is installed and activated is Plug and charge. Changing the Session Activation Method is done using the Smappee Dashboard. Changing the authentication methods can be done remotely.
	Scan and charge and Swipe and charge (with Smappee CSMS) can only be used when a Smappee Payment Agreement has been signed. See this article for more info.

Plug and charge

The charging station is freely accessible without the need to authorize. Anyone can plug their car into the charger and start charging for free.

Start charging

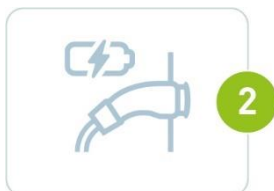

Stop charging

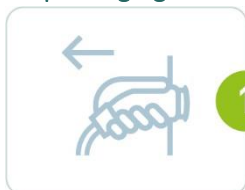

Swipe and charge

Charging sessions can be started using an RFID card. You can either use a Smappee Smart Charge Card for free charging or (if activated) a third party eMSP card to pay for charging sessions.

- **Whitelist:** charging is free with a Smappee Smart Charge Card or any other authorized RFID card. Once the charging cable is plugged-in, the user simply swipes their RFID card and the free charging session begins. All authorized cards must first be added to the whitelist using the 'Whitelisting' card on dashboard.smappee.net. See [this](#) article for more information. Cards can be ordered via the Smappee dashboard.
- **Public charging:** Other EV drivers can use this charging station and pay with an RFID card / token from a third-party eMSP. This can be done through Smappee's own CPO or through a third-party CPO. Public charging is activated using the Smappee dashboard. See the [Smappee Academy](#) for more information.
- **Split Billing:** This is aimed at employees who charge their company car at home and need to be reimbursed for the electricity consumption. Split billing agreements must be made for each employee. Starting a charging session is similar to whitelisting but at the end of each month, Smappee Services will send a bill for all employees' charging sessions to the company. All individual employees will be reimbursed according to the amount of kWh charged. Split billing is activated using the Smappee dashboard. See [this](#) article or the [Smappee Academy](#) for more information.

Start charging



Stop charging



Scan and charge

The user pays by credit card (Visa or Mastercard) using the Smappee app. They scan the QR code shown on the charging station and the app will guide them through the process of starting the charging session. It is also possible to set discount rates for specific users. Scan and charge is activated using the Smappee dashboard. See the [Smappee Academy](#) for more information.

Start charging

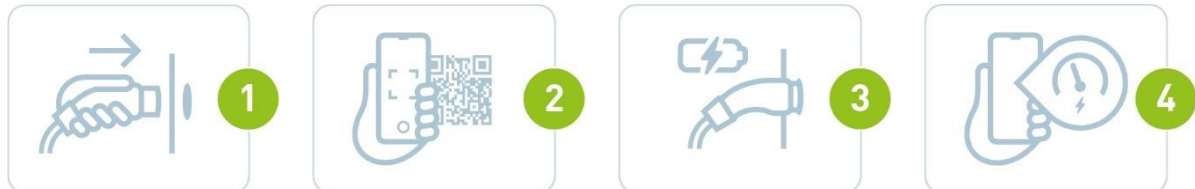

Stop charging



More information on how to use the Smappee EV Wall Home can be found on:
support.smappee.com/hc > Smappee EV Line

LED status

LED colour	LED status	Meaning	Action of the user
	White continuous	The Smappee EV Wall Home is available.	Connect your EV with the Smappee EV Wall Home.
	Blue continuous	Your EV is connected with the Smappee EV Wall Home, but is not yet charging.	<ul style="list-style-type: none"> • If using an RFID, scan your charge card and wait until the LED turns flashing blue. • If using QR codes, scan the QR code and wait until the LED is green pulsing. • If no authorisation is required, wait until the LED becomes green pulsing.
	Blue flashing	Your RFID card is being verified.	Wait until the LED is green pulsing.
	Green pulsing	The Smappee EV Wall Home is charging your EV.	Your EV is being charged.
	Green continuous	The EV is now fully charged.	Disconnect the cable.
	Green blinking	Charing session is paused by Smappee Smart Charging	This is informative, no action required.
	Red continuous	The Smappee EV Wall Home is unavailable.	Check the manual or contact your supplier for more info and further steps.
	Red flashing	Your charge card is not authorised.	Contact your charge card supplier.

9. Declaration of conformity

We,

Smappee nv
Evolis 104
B-8530 Harelbeke
Belgium

following the provision of the following EC Directives:

- 2014/35/EU The Low Voltage Directive
- 2014/30/EU The Electromagnetic Compatibility Directive
- 2011/65/EU RoHS Directive

hereby declare that the product:

EVW-132-BR-E-W, EVW-132-BR-E-W-100A, EVW-132-BR-E-B, EVW-132-BR-E-B-100A, EVW-132-BSR-E-W, EVW-132-C2R-E-W, EVW-132-C2R-E-W-100A, EVW-132-C2R-E-B, EVW-132-C2R-E-B-100A, EVW-132-C8R-E-W, EVW-132-C8R-E-W-100A, EVW-132-C8R-E-B, EVW-132-C8R-E-B-100A, EVW-332-BR-E-W, EVW-332-BR-E-W-100A, EVW-332-BR-E-B, EVW-332-BR-E-B-100A, EVW-332-BSR-E-W, EVW-332-C2R-E-W, EVW-332-C2R-E-W-100A, EVW-332-C2R-E-B, EVW-332-C2R-E-B-100A, EVW-332-C8R-E-W, EVW-332-C8R-E-W-100A, EVW-332-C8R-E-B, EVW-332-C8R-E-B-100A

is in conformity with the applicable requirements of the following documents

* Emissions:

(EN61326-1 : 2013)

Radiated Emission: EN 55011:2009 / EN 55032:2015 (Class B)

Conducted Emission: EN 55011:2009 / EN 55032:2015 (Class B)

Harmonic current Emission: EN 61000-3-2:2005 +A1:2008 + A2:2009

Flicker: EN 61000-3-3:2008

* Immunity:

(EN61326-1 : 2013)

ESD : EN 61000-4-2:2008 / EN 61000-4-2 :2009

Radiated immunity : EN 61000-4-3:2006 + A1:2007 + A2: 2010

Power frequency magnetic field: EN 61000-4-8:2009

Voltage dips/interruptions: EN 61000-4-11:2004

Common Mode Immunity: EN 61000-4-6:2008 / EN 61000-4-6:2009

Burst : EN 61000-4-4:2004 / EN 61000-4-4:2012

Surge: EN 61000-4-5:2005 / EN 61000-4-5:2006

* Safety:

Metering Function : IEC 61010-1 Ed 3.0 (2010-06) + A1:2016

AC Charging equipment : IEC 61851-1 (2017) / EN61558-1

* Other applicable standards and certifications: IEC 60364, IEC 62192-1, IEC 62192-2

Authorized signatory



Stefan Grosjean
CEO