

# PRESENTA

made in  
HOLLAND

**INTERNOVA**  
PROFESSIONAL LIGHTING

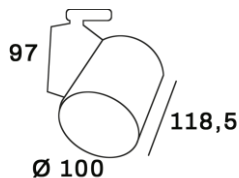

<b>Housing</b>	Aluminium, die cast
<b>RAL colour</b>	9004 (Black), 9003 (White), 9006 (Grey)
<b>Fixture type</b>	3-phase track light
<b>Module</b>	Philips Fortimo SLM LED module
<b>Driver</b>	Philips Xitanium LED Driver
<b>Lumen output</b>	1100lm, 2000lm, 3000lm, 4500lm
<b>CCT</b>	2700K, 3000K, 3500K, 4000K, 5700K
<b>CRI</b>	>80Ra, >90Ra
<b>Beam angles</b>	15°, 24°, 40°, 60°
<b>Adapter</b>	Powergear® 3-phase adapter included
<b>Rotatable</b>	350°
<b>Tiltable</b>	90°
<b>Expected Lifetime</b>	L80B10 >70.000 / L90B50 >50.000h
<b>Photobiological safety</b>	RG1 unlimited
<b>Power factor</b>	> 0.9
<b>LOR</b>	> 90%
<b>Colour consistency</b>	3 SDCM
<b>Warranty</b>	5 years warranty on LED module and driver

Net Weight	Dimensions carton L x W x H	Qty outer carton
1150 grams	10 x 10 x 31 cm	12

## LED MODULES

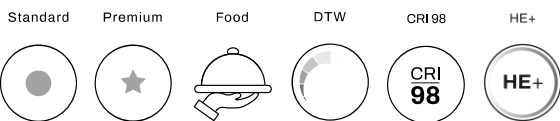

## OPTIONS

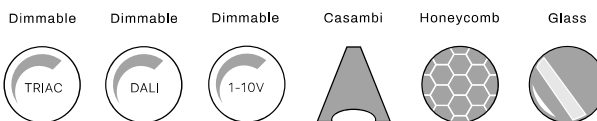

## LED MODULE OPTIONS

Description	Lumen	Watt	Lm/W	CCT	CRI	Description	Lumen	Watt	Lm/W	CCT	CRI
Philips Fortimo SLM G7	1100Lm	7W	157	827, 830	>80Ra	Philips Fortimo SLM G7	3000Lm	22W	136	927, 930, 930PW	>90Ra
Philips Fortimo SLM G7	1100Lm	6W	183	840, 857	>80Ra	Philips Fortimo SLM G7	3000Lm	20W	150	935PW, 940PW	>90Ra
Philips Fortimo SLM G7	1100Lm	8W	138	927, 930, 930PW	>90Ra	Full Spectrum	3000Lm	21W	143	930FS, 940FS	>90Ra
Philips Fortimo SLM G7	1100Lm	7W	157	935PW, 940PW	>90Ra	Food Warm White	3000Lm	31W	97	925 FWW	>90Ra
Full Spectrum	1100Lm	8W	138	930 FS, 940 FS	>98Ra	Meat Premium Red	2400Lm	36W	68	920 MPR	>90Ra
Food Warm White	1100Lm	11W	100	925 FWW	>90Ra	Fresh Fish	3000Lm	34W	88	940 FF	>90Ra
Meat Premium Red	1100Lm	16W	69	920 MPR	>90Ra	Philips Fortimo SLM G7	4500Lm	27W	166	827, 830	>80Ra
Fresh Fish	1100Lm	13W	85	940 FF	>90Ra	Philips Fortimo SLM G7	4500Lm	27W	166	840, 857	>80Ra
Dim-to-Warm (DTW)	1100Lm	13W	85	2200K-3000K	>90Ra	Philips Fortimo SLM G7	4500Lm	33W	136	927, 930, 930PW	>90Ra
Philips Fortimo SLM G7	2000Lm	15W	167	827, 830	>80Ra	Philips Fortimo SLM G7	4500Lm	30W	150	935PW, 940PW	>90Ra
Philips Fortimo SLM G7	2000Lm	12W	167	840, 857	>80Ra						
Philips Fortimo SLM G7	2000Lm	15W	133	927, 930, 930PW	>90Ra						
Philips Fortimo SLM G7	2000Lm	14W	143	935PW, 940PW	>90Ra						
Full Spectrum	2000Lm	17W	118	930 FS, 940 FS	>98Ra						
Food Warm White	2000Lm	22W	91	925 FWW	>90Ra						
Meat Premium Red	2000Lm	30W	67	920 MPR	>90Ra						
Fresh Fish	2000Lm	22W	91	940 FF	>90Ra						
Dim-to-Warm (DTW)	1900Lm	20W	95	2200K-3000K	>90Ra						
Philips Fortimo SLM G7	3000Lm	19W	158	827, 830	>80Ra						
Philips Fortimo SLM G7	3000Lm	18W	166	840, 857	>80Ra						

### LED modules

Standard: CRI>80 and >90 in CCT 2700K, 3000K, 3500K, 4000K

Premium White (PW): for fresh white and depth of colour in retail environments

1) Lumen output of LED module (COB)

2) Mentioned wattage applies for the COB only. Mentioned wattage applies for the most efficient CCT.

The power of the complete fixture will be slightly higher due to the power consumption of the driver.

3) Values shown are average values and are subject to +/- 10% tolerance (set by international standards). The colour temperature is subject to a tolerance of up to +/- 150 Kelvin compared to the nominal value.

Technical data can be changed by Internova without prior notice.

**It all starts with light**

## ARTICLE CODE STRUCTURE

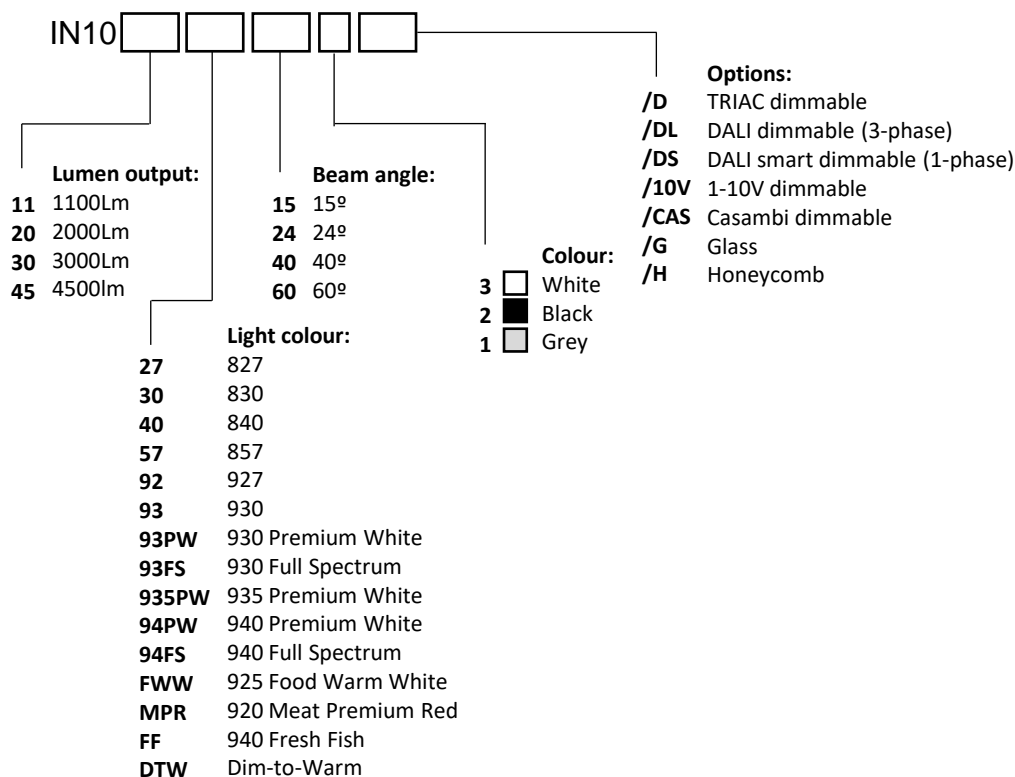

## POLAR DIAGRAMS

15°

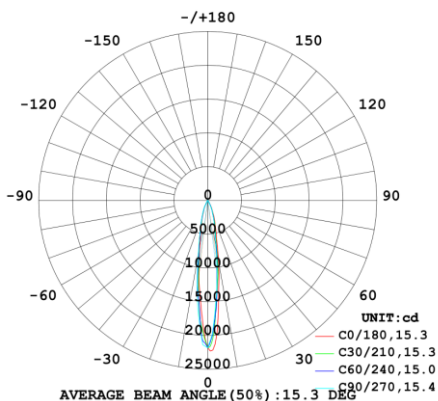

24°

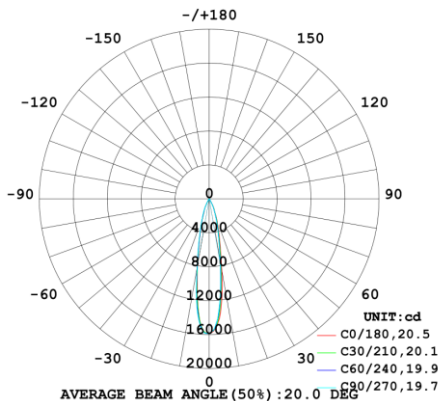

40°

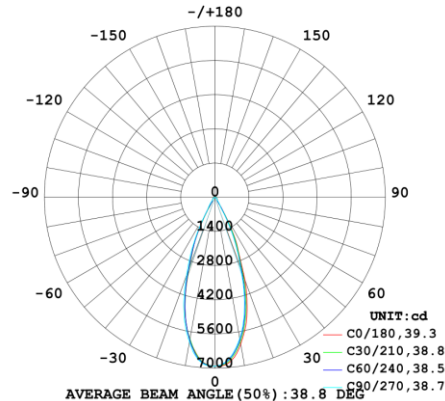

**It all starts with light**